

# OR 1/2 E6 C

## ORTA Tap Range Orta Basin Taps Eco6 Chrome



### Features:

- Supplied with metal handles
- Supplied with metal backnuts
- Product supplied with 2 x 3 litre per minute flow regulators which can be inserted into the threaded tail to reduce water consumption and increase water efficiency (Flow Regulator accurate +/- 10%)

### Product Certifications:



For more products, visit our website:  
<http://www.bristan.com>



### Specification

<b>Product Type:</b>	Bathroom Taps
<b>Main Construction Material:</b>	Brass
<b>Mount Type:</b>	Deck
<b>Handle Type:</b>	Lever
<b>Connection Inlet:</b>	1/2" BSP
<b>Connection Outlet:</b>	M16 Aerator
<b>Number of Tap Holes:</b>	2
<b>Valve/Cartridge Type:</b>	1/2" Ceramic Disc Valve
<b>Plumbing System Requirements:</b>	Suitable for all plumbing systems
<b>Minimum Dynamic Pressure (bar):</b>	0.2 bar
<b>Maximum Dynamic Pressure (bar):</b>	5.0 bar
<b>Maximum Hot Water Temperature °C:</b>	65°C
<b>Maximum Static Pressure (bar):</b>	10 bar
<b>Isolation Included:</b>	No

### Dimensions (measurements in mm)

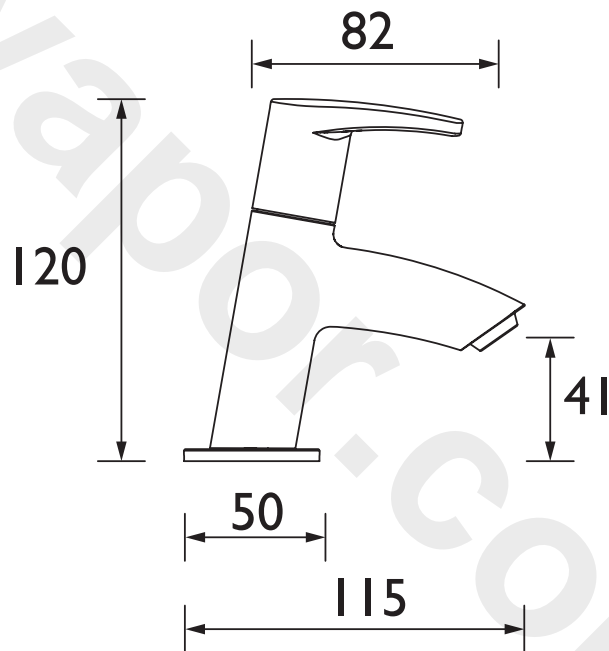

### Flow Rates (l/min)

System Pressure (bar)	0.2	0.5	1	2	3	5
OR 1/2 E6 C (Cold)	3	3	3	3	3	3
OR 1/2 E6 C (Hot)	3	3	3	3	3	3

## TECHNICAL DATA SHEET



# BRISTAN

D4